





Opal Twin Shower set



SPECIFICATION

OVERHAND SHOWER WELS RATING	3STAR 9L/Min
HAND SHOWER WELS RATING	3STAR 9L/Min
WATERMARK LICENSE	WM-060093
TEMPERATURE RATING	Min 1°C-Max 75°C
PRESSURE RATING	Min 150KPa-Max 500Kpa

AVAILABLE FINISH

	GRAPHITE NR251905eGR		BRUSHED NICKEL NR251905eBN
	BRUSHED BRONZE NR251905eBZ		BRUSHED GOLD NR251905eBG

MAINTENANCE AND CARE

All surfaces should be cleaned with mild liquid detergent or soap and water. Do not use cream cleaners or citrus based cleaning products, as they are abrasive. Use of unsuitable cleaning agents may damage the surface. Any damage caused in this way will not be covered by warranty.

PACKING INCLUDES

- 1x hand shower (built-in check valve)
- 1x shower head
- 1x shower arm
- 1x shower rail
- 1x1.5m PVC hose
- 2x back plates
- 1x slider bracket

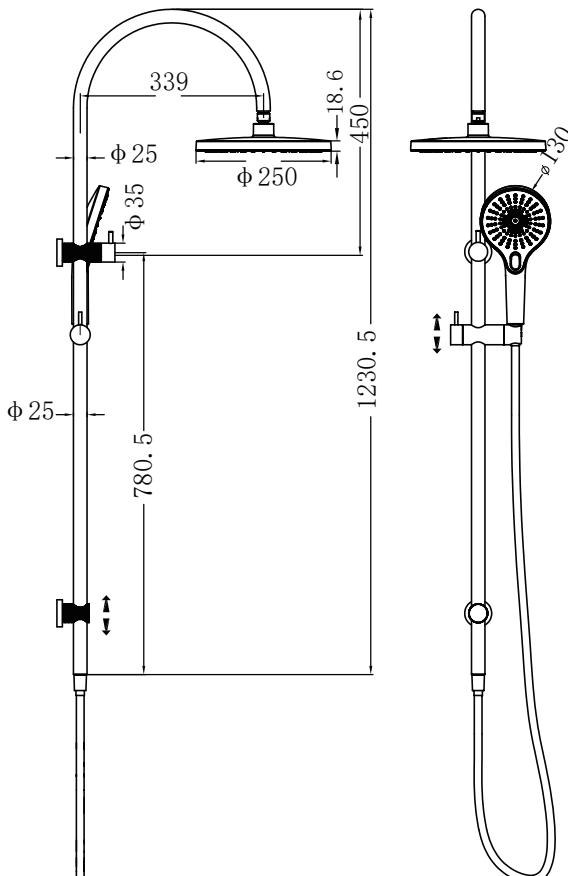

Important

All products must be installed by licensed plumbers.

All pipework must be thoroughly flushed prior to installation, as foreign materials may block the flow regulating device and reduce the flow of water.

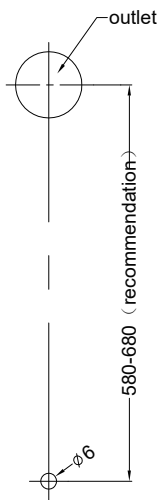

1. Drill a $\phi 6$ mm hole at the downwards outlet vertical downward position in the recommended range.

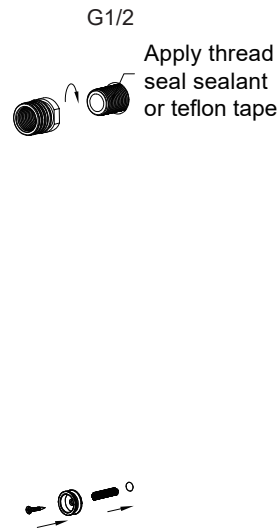

2. Screw the adapter onto the outlet. Push wall plug into drilled hole. Fit lower mounting pillar in place with screw. Tighten firmly.

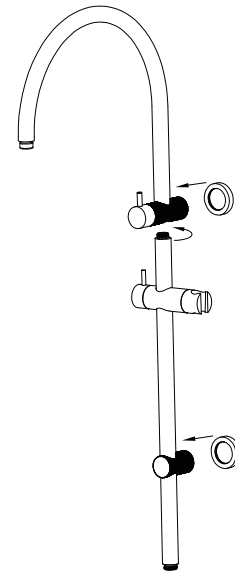

3. Screw shower rail into shower arm component. Tighten firmly. Push 2 back plates onto shower arm component and lower mounting pillar.

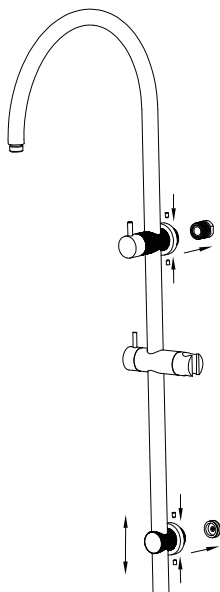

4. Locate and push shower rail assembly onto wall adapters. Tighten grub screws firmly with allen key provided. Slide the back plates against the wall/tile face properly.

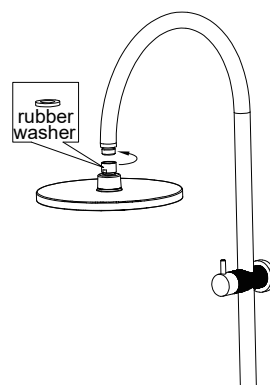

5. Screw shower head to shower arm with care. (Note the rubber washer in the shower head.)

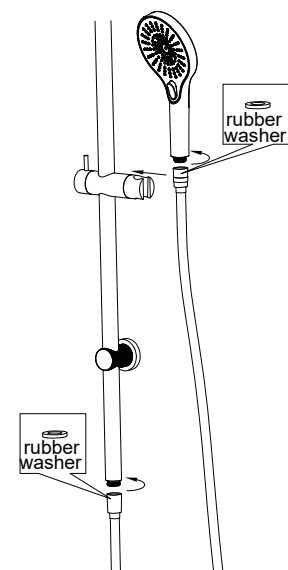

6. Please noted the rubber washer in the hand shower. Connect shower rail and hand shower with hose. **TEST & CHECK FOR LEAKS.**