

ZUMI

Multi-function Bath Heater Instruction Manual

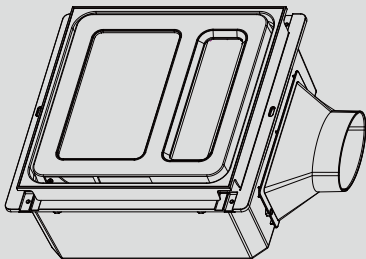

Model : XD-AYB-ZM-01

Before installing and using this product, please read this manual carefully and keep it properly for future reference.

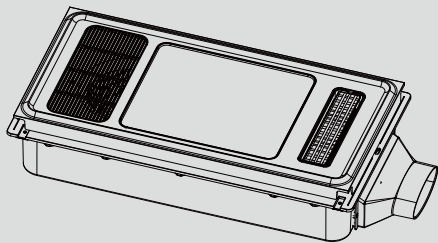

Model : XD-AYB-ZM-03

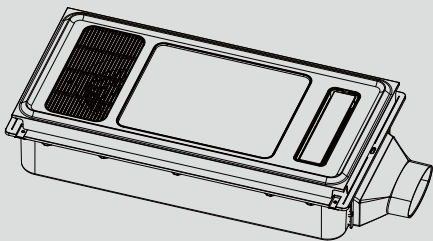

Model : XD-AYB-ZM-04

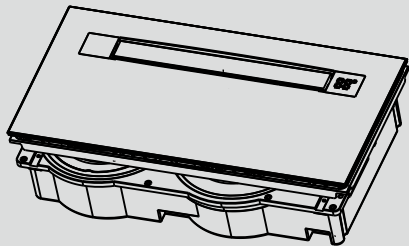

Model : XD-AYB-ZM-05WH

Before installing and using this product, please read this manual carefully and keep it properly for future reference.

Warning

- 1、 The weight of this product is 3.5 Kg.
- 2、 the appliance is not to be used by persons (including children) with reduced physical, sensory or mental capabilities, or lack of experience and knowledge, unless they have been given supervision or instruction.
- 3、 children being supervised not to play with the appliance.
- 4、 heater is not located immediately below a socket-outlet.
- 5、 Instructions for heaters for mounting at high level state that the heater must be installed at least 1,8 m above the floor.
- 6、 Instructions for fixed heaters likely to be used in a bathroom: that the heater is to be installed so that switches and other controls cannot be touched by a person in the bath or shower.
- 7、 Statement for heaters intended to be installed in wardrobes or ceiling: for proper installation in a wardrobe or in the ceiling.
- 8、 The appliance shall, under no circumstances, be covered with insulating material or similar material.
- 9、 Regulations concerning the discharge of air have to be fulfilled.
- 10、 Joists, beams and rafters shall not be cut or notched to install the appliance.
- 11、 Stationary appliances not fitted with means for disconnection from the supply mains having a contact separation in all poles that provide full disconnection under overvoltage category III, the instructions state that means for disconnection must be incorporated in the fixed wiring in accordance with the wiring rules.
- 12、 that the fan is to be installed so that the blades are more than 2,1 m above the floor.

Contents

■ Product Features	3
■ Safety Guidelines	3
■ Packing List	4
■ Dimensions	5
■ Product Installation	7
Installation Precautions	7
Installation Steps	10
■ Precautions for daily use and maintenance	16
■ Identification and handling of common faults	20
■ Specifications and electrical schematics	21
■ Warranty card	22

Product Features

Thank you for buying ZUMI product.

Comprehensive Solution, Easy Choice! The ZUMI Multi-functional Heater Series allows you to effortlessly own a bathroom ceiling with personalized design and overall functionality, showcasing the technological quality of your home life.

■ Tailored Design for You

Various Functions,
Free Combination
Fits Flush with Ceiling,
Neat and Beautiful

■ Easy Experience

One-stop Purchase,
Time-saving Ease
Integrated Design,
Easy Installation

■ Technological Enjoyment

LED Light Source,
Energy-efficient
Quality Assurance,
Confidence in Choice

Safety Guidelines

Please be sure to follow the operating instructions listed in this installation manual.

To avoid any unsafe factors, the following safety precautions listed in this manual must be read carefully, understood correctly, and strictly observed, disregard or violation of the following operations will possibly cause personal injuries or property damage.

Please keep this manual properly for future reference.

Implementation standards:







AS/NZS 60335.2.30: 2015+A1:2015+A2:2017+A3:2020+A4:2021

AS/NZS 60335.1:2022; IEC 60598-1; IEC 60598-2-2+deviation

AS/NZS CISPR 14.1:2021; AS/NZS CISPR 15:2011, AS CISPR 15:2017

Packing List

The following accessories are included in the product package. Please check whether they are complete after unpacking. If not, please contact the ZUMI after-sales service center or distributor.

Number	Picture	Name	Quantity
1		Heater	1
2		Ventilation duct	1
3		Accessory kit (Includes: Installation clasp 4, Tapping screw 4, iron hoop 2, vent window 1)	1
4		Switch (Includes two M4x20 screws)	1
5		Instruction manual (includes warranty card, certificate of qualification)	1
6		Conversion frame	1
7		Template	1

(Tab 1)

Dimensions

Model: XD-AYB-ZM-01

Units: mm

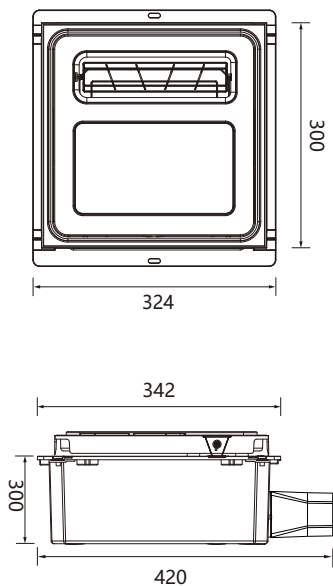

Dimensions

Model: XD-AYB-ZM-03/04

Units: mm

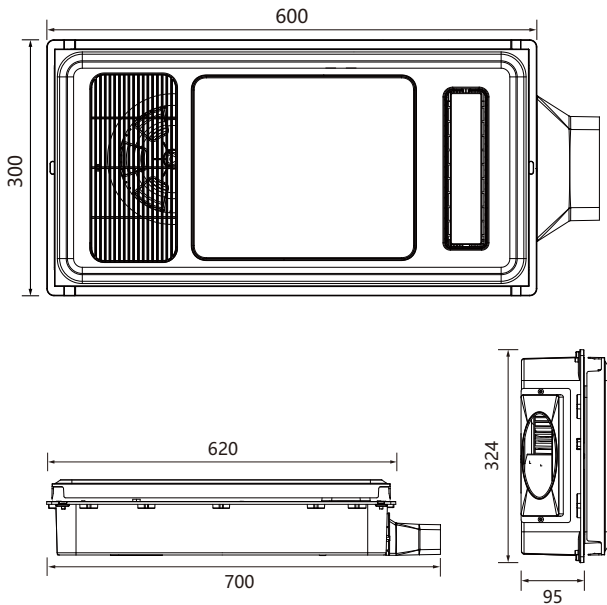

Dimensions

Model: XD-AYB-ZM-05WH

Units: mm

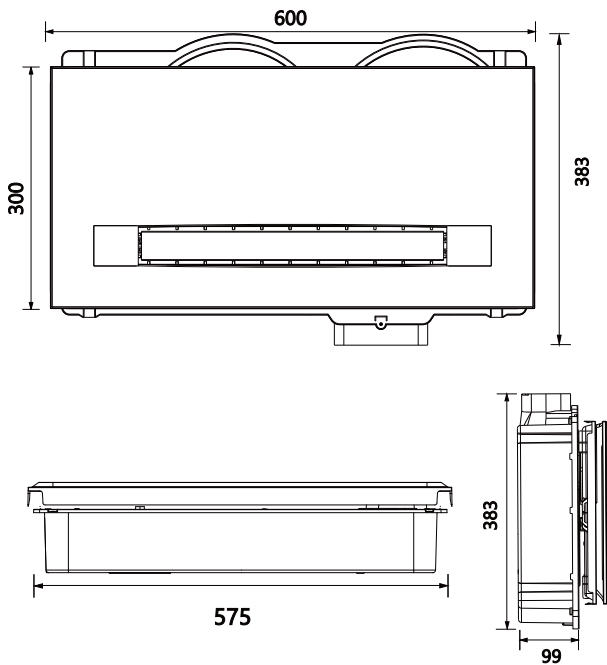

Product Installation

Installation Precautions

Notice

1. Installation environment

- 1.1 Please do not install in a seriously dusty environment.
- 1.2 Please install it in a place with a temperature of $-10\sim 45^{\circ}\text{C}$.
- 1.3 Please do not install in kitchens or other places where there is a lot of grease and smoke.
- 1.4 Please do not install it in a place where it may be splashed by water.
- 1.5 Please do not install the product outside a window or on a wall.
- 1.6 The exhaust function of this heater cannot be used to discharge harmful or explosive substances and vapors.
- 1.7 Sufficient air inlets into the bathroom are required.

2. Installation conditions

- 2.1 Please do not install on any bracket that is not securely fixed. The weight of this product is 3.5 Kg and the frame used to support and install this product must be able to bear a weight of not less than 13kg.
- 2.2 Please do not install on a sloping ceiling (as shown in Figure 2).
- 2.3 Avoid bending the ventilation duct more than 90 degrees after it has been installed (Fig. 3).

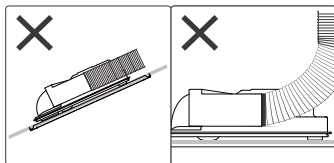

(Fig.2)

(Fig.3)

- 2.4 Prohibit other objects from covering the surface of the machine after the heater is installed.

3. Installation location

- 3.1 The installation height must be at least 2.3m above the floor.
- 3.2 The distance between the ceiling used to install this product and the top of the house must be more than 0.18m.

- 3.3 The minimum distance between the product and the wall after installation must be greater than 0.3m.
- 3.4 The distance from curtains and other flammable materials should be greater than 0.3m.

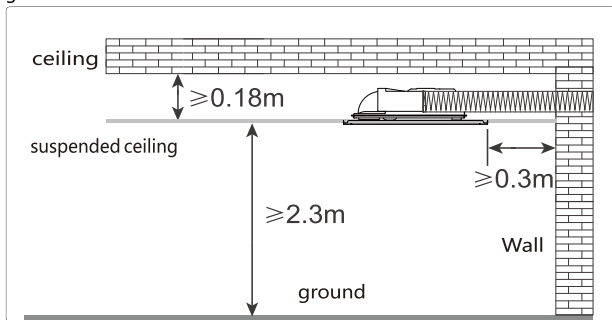

(Fig.4)

4. Installation circuit requirements

- 4.1 This product cannot be used under a power outlet.

5. Warning

- 5.1 A protection switch (overvoltage level III,) must be installed on the power supply line of the fixed machine, and the switch must be installed in a convenient place outside the bathroom.

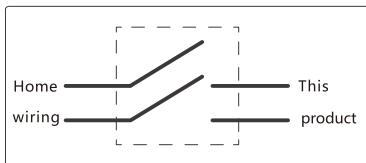

(Fig.5)

- 5.2 The power cord must use a fixed wiring cable. The cable should be installed in a suitable wiring duct. It is recommended to use flexible cables that comply with local standards, with a conductor cross-sectional area of $3 \times 1.5\text{mm}^2 \leq S \leq 3 \times 2.5\text{mm}^2$. The stripped length of the cable at the power cord end should be 8mm. Ensure that the cables are securely connected to prevent the risk of fire.

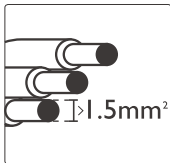

(Fig.6)

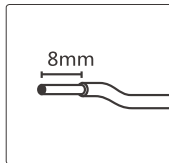

(Fig.7)

- 5.3 Please do not use power sources other than 220-240V ~50Hz.
- 5.4 When installing, please install a qualified leakage protection switch (leakage current is below 30mA).
- 5.5 The product shall be installed so that switches and other controls are not accessible to people persons in the bathtub or shower area.
- 5.6 Power must be disconnected before touching and installing the product to prevent electric shock from occurring.
- 5.7 Do not touch the ventilator fan and PTC outlet grille while in operation.

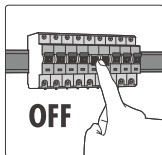

(Fig.8)

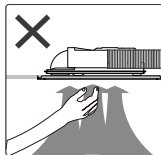

(Fig.9)

- 5.8 It is prohibited to attach or cover any objects to the product's air inlet and outlet grilles.
- 5.9 It is prohibited to install the product near curtains and other flammable materials.
- 5.10 If the power cord is damaged, it must be replaced with a special cord or component.
- 5.11 Installation and maintenance of this product must be carried out by qualified professionals, ensuring that children do not treat this product as a toy.
- 5.12 It is prohibited to directly spray and clean this product with water or other liquids.

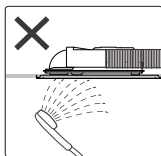

(Fig.10)

Installation Steps

1. Check the suspended ceiling

- 1.1 The thickness of the ceiling plasterboard is 10mm.
- 1.2 The height of the ceiling is more than 180mm.
- 1.3 The minimum distance between the product and the wall after installation must be greater than 0.3m.
- 1.4 The distance from curtains and other flammable materials should be greater than 0.3m.

2. Cut out a hole

- 2.1 Cut out a rectangular holes at appropriate locations in the ceiling (See Figure 11)

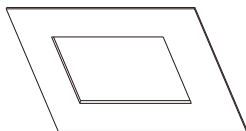

XD-AYB-ZM-01
Rectangular hole
dimensions: 310 × 310

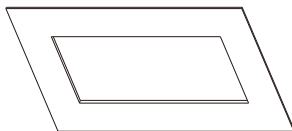

XD-AYB-ZM-03/04/05
Rectangular hole
dimensions: 308 × 608

(Fig.11)

- 2.2 Fix the two spacer blocks to the two long holes on the same side of the Conversion frame with self-tapping screws. Do not tighten the self-tapping screws. The spacer blocks can be moved

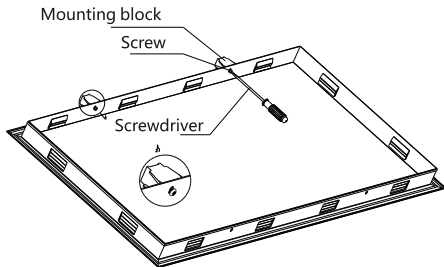

(Fig.12)

2.3 Insert the side of the Conversion frame with the spacer block into the long side of the hole in the ceiling so that the Conversion frame is stuck on the ceiling through the spacer block. Push the Conversion frame into the ceiling hole in the direction shown in the figure

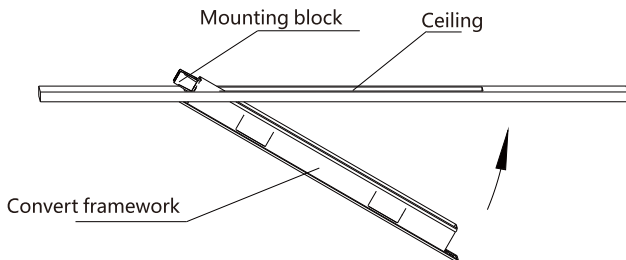

(Fig.13)

2.4 Fix the other two spacer blocks in the long hole on the other long side of the Conversion frame with self-tapping screws. Tighten all 4 self-tapping screws to firmly fix the Conversion frame to the ceiling

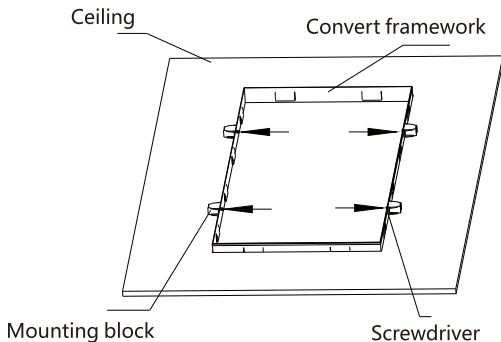

(Fig.14)

3 Cut out a hole for ventilation

Determine the position of the vent on the wall (it should be slightly below the outlet of the exhaust fan, just above the ceiling, to prevent condensation water from flowing back into the main unit), and open a round hole at that location with a hole diameter larger than the diameter of the vent.

4 Install the vent window connector

Put one end of the ventilation duct on the ventilation window, tighten it with an iron hoop, fix the ventilation window at the air outlet of the exterior wall, and fill the gap between the ventilation pipe and the ventilation hole on the wall with foaming agent (as shown in the figure below).

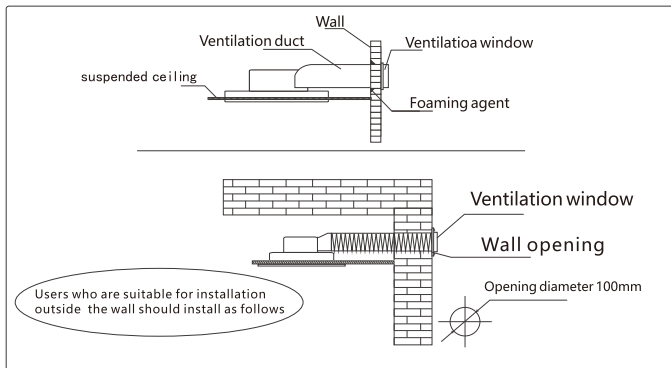

(Fig.15)

5 Install the buckle

5.1 Fix the four sets of fasteners to the slots on either side of the heater, and use two screws to secure the air outlet. Fix the four sets of fasteners to the slots on either side of the heater, and use two screws to secure the air outlet, as shown in figure.16 and figure.17

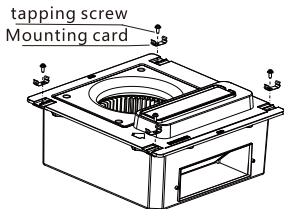

(fig.16)

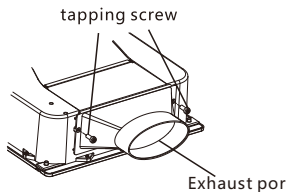

(fig.17)

XD-AYB-ZM-01

5.1 Fix the four sets of fasteners to the slots on either side of the heater, and use two screws to secure the air outlet. Fix the four sets of fasteners to the slots on either side of the heater, and use two screws to secure the air outlet, as shown in figure.18 and figure.19

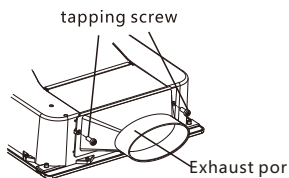

(Fig.18)

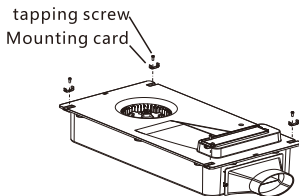

(Fig.19)

XD-AYB-ZM-03/04

5.3 Fix the four sets of fasteners to the slots on either side of the heater, and use two screws to secure the air outlet. Fix the four sets of fasteners to the slots on either side of the heater, as shown in figure.20

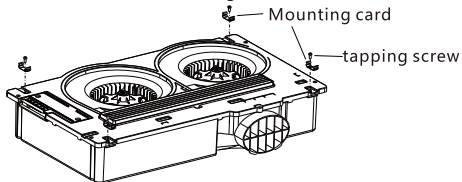

XD-AYB-ZM-05

(Fig.20)

6. Fix the multi-function heater

- 6.1 Insert the plug on the heater into the pre-installed socket;
- 6.2 Install the vent pipe, stretch the installed ventilation duct to the heater, put it on the air outlet, and lock the clamp at the connection;

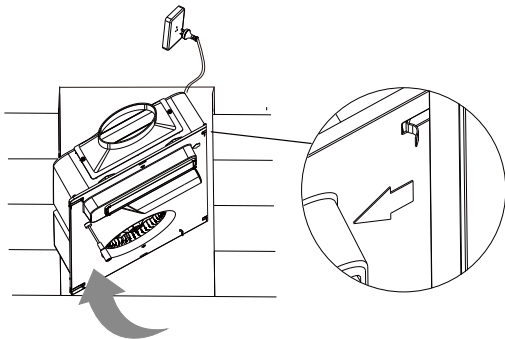

(Fig.21)

- 6.3 Insert the main unit with the buckles installed at the four corners into the ceiling through the conversion frame hole, as shown in Figure 18. Align the slots on the four buckles with the edge of the conversion frame so that the heater is stuck on the conversion frame, as shown in the figure below.

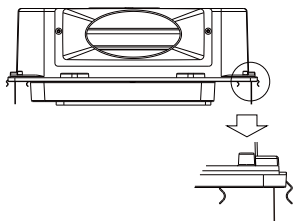

XD-AYB-ZM-01/03/04

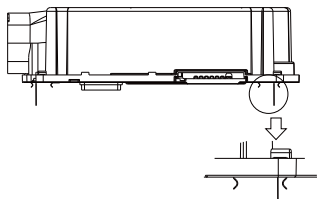

XD-AYB-ZM-05

(Fig.22)

7. Panel installation

7.1 Panel installation for XD-AYB-ZM-01.

7.1.1 Adjust the heater to the center position.

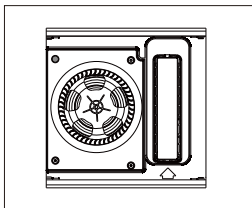

(Fig.23)

7.1.2 Connect the LED light wires properly. Install the panel as shown in the figure below. The panel air outlet window must be aligned with the heater air outlet, see Figures below.

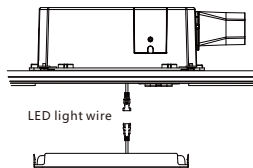

(Fig.24)

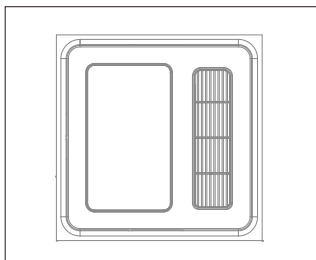

(Fig.25)

7.1.3 Power on and run to confirm whether it is operating normally, the installation is complete.

7.2 Panel installation for XD-AYB-ZM-03/04

7.2.1 Adjust the heater to the center position.

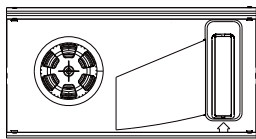

(Fig.26)

7.2.2 Connect the LED light wires properly. Install the panel as shown in the figure below. The panel air outlet window must be aligned with the heater air outlet, see Figures below.

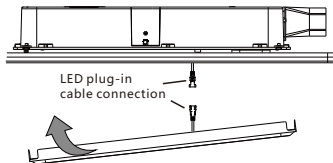

(Fig.27)

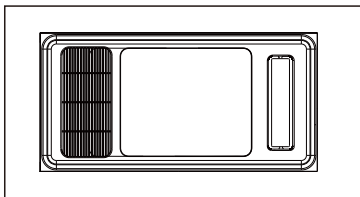

(Fig.28)

7.2.3 Power on and run to confirm whether it is operating normally, the installation is complete.

7.3 Panel installation for XD-AYB-ZM-05WH

7.3.1 Adjust the heater to the center position.

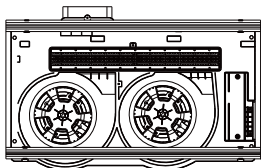

(Fig.29)

7.3.2 Connect the LED light wires properly. Install the panel as shown in the figure below. The panel air outlet window must be aligned with the heater air outlet, see Figures below.

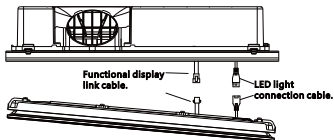

(Fig.30)

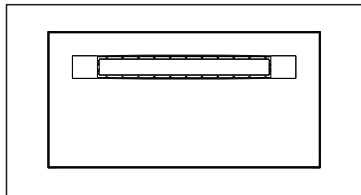

(Fig.31)

7.3.3 Power on and run to confirm whether it is operating normally, the installation is complete.

8. Installation of Function Control Switch

8.1 Remove the switch installation frame, open the battery compartment cover, and insert two AAA batteries into the battery compartment

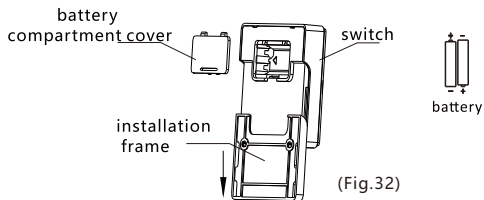

8.2 Method 1: Use the provided 2 M4x20 machine screws to secure the installation frame to the wall, as shown in Figure 23, and then push the main body of the switch into the installation frame see Figure 24.

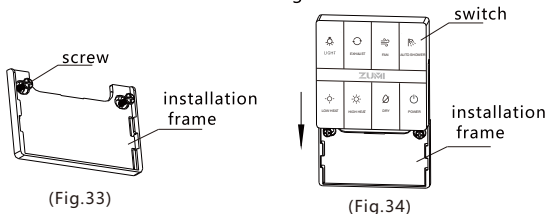

8.3 Method 2: Use 3M adhesive tape to directly stick the installation frame to the wall as shown in Figure 25, and then push the main body of the switch into the installation frame see Figure 26.

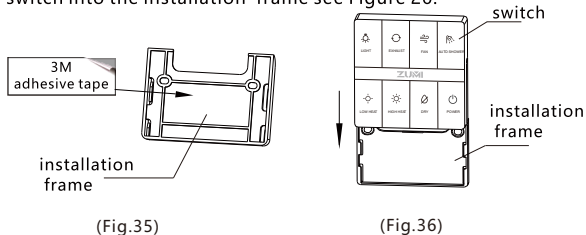

8.Installation of Function Control Switch

8.1 Remove the switch installation frame, open the battery compartment cover, and insert two AAA batteries into the battery compartment

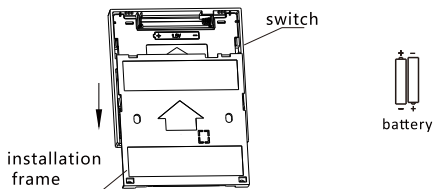

(Fig.22)

8.2 Method 1: Use the provided 2 M4x20 machine screws to secure the installation frame to the wall, as shown in Figure 23, and then push the main body of the switch into the installation frame see Figure 24.

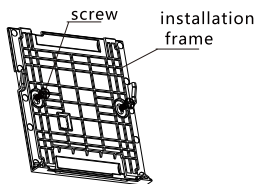

(Fig.37)

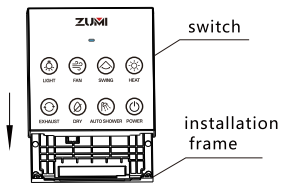

(Fig.38)

8.3 Method 2: Use 3M adhesive tape to directly stick the installation frame to the wall as shown in Figure 25, and then push the main body of the switch into the installation frame see Figure 26.

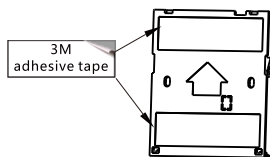

(Fig.39)

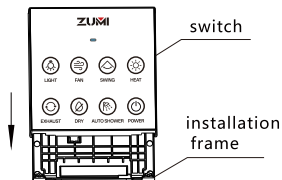

(Fig.40)

8. Installation of Function Control Switch

8.1 Remove the switch installation frame, open the battery compartment cover, and insert three AAA batteries into the battery compartment

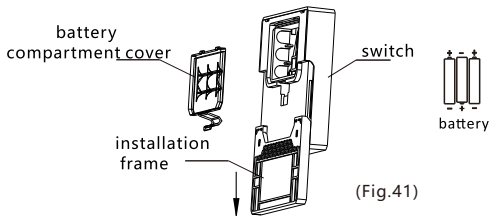

8.2 Method 1: Use the provided 2 M4x20 machine screws to secure the installation frame to the wall, as shown in Figure 24, and then push the main body of the switch into the installation frame see Figure 25.

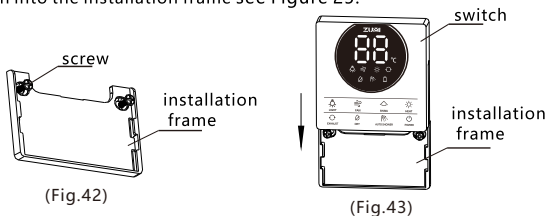

8.3 Method 2: Use 3M adhesive tape to directly stick the installation frame to the wall as shown in Figure 26, and then push the main body of the switch into the installation frame see Figure 27.

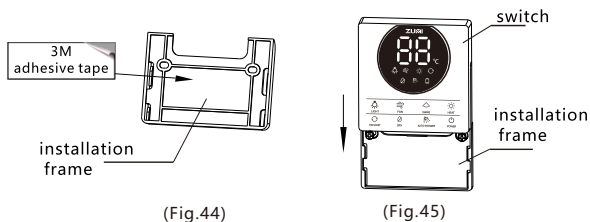

Daily use and maintenance

Operation instructions for daily use functions

Model: XD-AYB-ZM-01/03

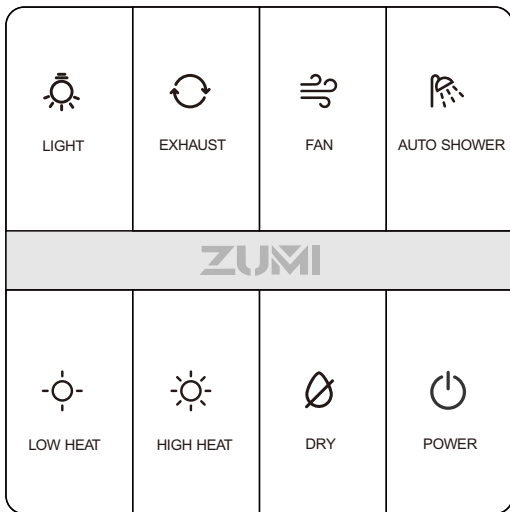

(Fig.46)









- This product has been paired before delivery, and it needs to be paired again when replacing the switch.

Pairing:

Power off and then on the main unit. Within 5s, continuously press the standby button. Buzzer "beep" sound for 2 seconds, pairing succeed.

Reminder:

Use 2 AAA (N0.7) batteries. Remove them if not used for a long time.

Button	Function Mode
 LIGHT	Press this button, light on; Press the button again, light off.
 EXHAUST	Press this button, exhaust on; Press the button again, exhaust off. Note: Blowing and exhaust can be turned on at the same time
 FAN	Press this button, fan on; Press the button again, fan off. Note: Blowing and exhaust can be turned on at the same time
 AUTO SHOWER	Control the unit's on/off, high/low gear adjustment, with automatic switching between heating and ventilation to ensure a non-stuffy bathing experience.
 LOW HEAT	Press this button, normal heating on Press the button again, normal heating off, fan off 15 seconds later Note: Heating and exhaust can be turned on at the same time
 HIGH HEAT	Press this button, strong heating on Press the button again, strong heating off, fan off 15 seconds later Note: Heating and exhaust can be turned on at the same time
 DRY	Control the on/off of the dry function for warm air drying.
 POWER	Press this button, all functions are off. If the heating/drying is working at this time, the fan blowing will be turned off with a delay of 15 seconds.

(Tab 2)

Note: If there is no operation for two hours, the system will execute the shutdown command and exit all working modes.

Model: XD-AYB-ZM-04

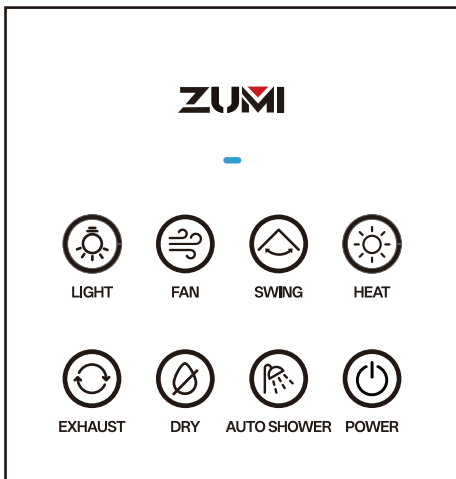

(Fig.47)

- This product has been paired before delivery, and it needs to be paired again when replacing the switch.

Pairing:

Power off and then on the main unit. Within 5s, continuously press the standby button. Buzzer "beep" sound for 2 seconds, pairing succeed.

Reminder:

Use 2 AAA (N0.7) batteries. Remove them if not used for a long time.

Model: XD-AYB-ZM-05WH

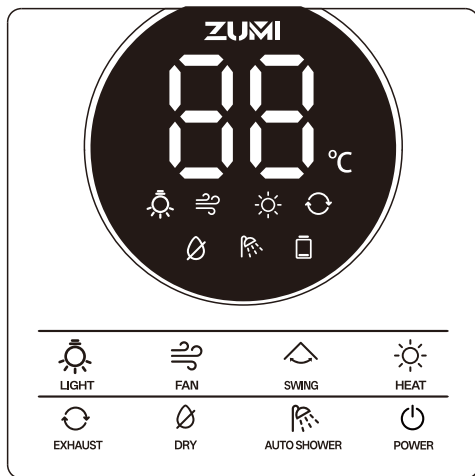

(Fig.48)









- This product has been paired before delivery, and it needs to be paired again when replacing the switch.

Pairing:

Power off and then on the main unit. Within 5s, continuously press the standby button. Buzzer "beep" sound for 2 seconds, pairing succeed.

Reminder:

Use 3 AAA (N0.7) batteries. Remove them if not used for a long time.

Button	Function Mode
 LIGHT	Press this button, light on; Press the button again, light off.
 FAN	Press this button, fan on; Press the button again, fan off. Note: Blowing and exhaust can be turned on at the same time
 SWING	Touch this button, Swing mode on; Touch the button again, Swing mode off, and leaves reset.
 HEAT	Press this button, strong heating on Press the button again, strong heating off, fan off 15 seconds later Note: Heating and exhaust can be turned on at the same time
 EXHAUST	Press this button, exhaust on; Press the button again, exhaust off. Note: Blowing and exhaust can be turned on at the same time
 DRY	Control the on/off of the dry function for warm air drying.
 AUTO SHOWER	Control the unit's on/off, high/low gear adjustment, with automatic switching between heating and ventilation to ensure a non-stuffy bathing experience.
 POWER	Press this button, all functions are off. If the heating/drying is working at this time, the fan blowing will be turned off with a delay of 15 seconds.

(Tab 3)

Note: If there is no operation for two hours, the system will execute the shutdown command and exit all working modes.

Maintenance precautions

1. Before cleaning and maintenance, please ensure that the power is disconnected, the wind wheel has stopped rotating, and the temperature of the heating component (PTC) has dropped to close to the ambient temperature.
2. It is prohibited to disassemble this product for repair and modification. When repairing, you must go to a designated repair shop with the warranty certificate for repair.
3. Do not use gasoline, benzene solvent, or any similar chemicals to clean this product.
4. The motor and electrical connection parts must not come into contact with water.
5. Plastic parts cannot be immersed and washed with hot water above 60°C.
6. Do not use hard objects, iron brushes, etc. to scratch the surface of the plastic panel. Only wipe with a soft brush or towel.

Identification and Handling of Common Faults

In case of malfunction, please refer to the following table for inspection. If the problem still cannot be solved, please ensure that the "power bipolar switch" connected to this product is disconnected and contact the customer consultation center or dealer as soon as possible.

Failures	Reasons	Handle
Exhaust air volume becomes smaller	The air duct may be improperly installed or bent too much.	Please check whether the product is installed according to the instructions.
Hot air is not hot	The heater may be damaged.	Please contact your dealer.
No hot air	The heater may be damaged.	Please contact your dealer.
	The controller may be damaged.	Please contact your dealer.
Unusual noise	The machine body may not be installed securely or the ceiling keels may be loose.	Please check whether the product is installed according to the instructions.
	The fan blade may be deformed or damaged.	Please contact your dealer.
	There might be unusual objects inside.	Please check whether the product is installed according to the instructions.
Switch failure	Battery is low.	Please replace a new battery.

(Tab 4)

Specifications: XD-AYB-ZM-01

Voltage	Frequency	Rated Power	Heating Power	Blowing Power
220~240V	50Hz	2050W	2040W	40W
Ventilation Power	Lighting Power	Heat	Exhaust	Ventilation Volume
40W	10W	45dB	45dB	100m ³ /h

(Tab)

Specifications: XD-AYB-ZM-03/04/05WH

Voltage	Frequency	Rated Power	Heating Power	Blowing Power
220~240V	50Hz	2498W	2440W	40W
Ventilation Power	Lighting Power	Heat	Exhaust	Ventilation Volume
40W	18W	52dB	52dB	150m ³ /h

(Tab)

Instructions:

- Motor: Class B insulation.
- Waterproof rating: IPX2.
- The noise value is an A-weighted average sound pressure level, which is the central value of the nationally recognized laboratory test results, with a tolerance range of +3dB and -7dB.
- The above parameters are subject to change without prior notice.

Electrical Schematic

Diagram:

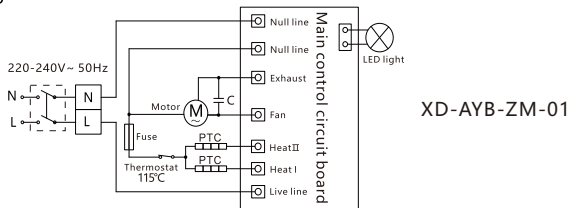

(Fig.49)

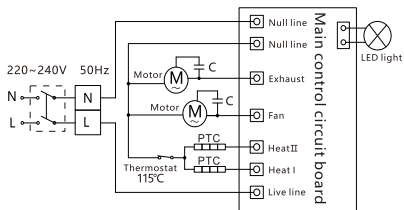

XD-AYB-ZM-03

(Fig.50)

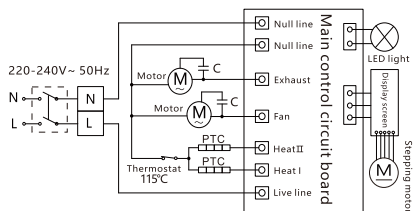

XD-AYB-ZM-04

(Fig.51)

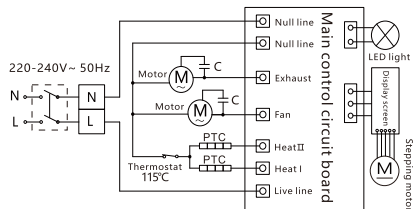

XD-AYB-ZM-05WH

(Fig.52)

Note: If you need to purchase a replacement switch, be sure to purchase it directly from a ZUMI distributor or specialty store to avoid any danger or failure to function properly due to incorrect wiring or the use of the wrong switch.

ZUMI Lighting Product Warranty Card

Warranty terms:

The company guarantees that this product can perform its superior performance under normal use and maintenance. At the same time, the company will provide one year warranty service for licensed users (excluding light sources).

1. Within one year from the date of purchase, you will receive warranty service for any failure or damage that is confirmed by the company to be caused by quality problems of the product itself under normal use.
2. This warranty service includes lamps and accessories and auxiliary devices included in the lamps.
3. When applying for warranty service, consumers must provide this warranty card and a valid proof of purchase.
4. Warranty service will not be available under the following circumstances:
 - 1) No production date, alteration of the production date, tear off or switch the production date sticker;
 - 2) The product has been disassembled, modified, or repaired by authorized personnel of the company;
 - 3) Products that have exceeded the warranty validity period;
 - 4) Normal use of the product caused by aging, wear and tear, scratches, scrapping paints, etc., does not affect the normal use of the product;
 - 5) Non-quality problems caused serious damage to the product shell (including deformation, oxidation, corrosion, or severe water damage, etc.);
 - 6) Damage caused by improper Use, such as incorrect power supply, use of inappropriate accessories, improper installation, failure to follow the instructions, misuse, or negligence;
 - 7) Damage caused by force majeure factors, such as flood, fire, earthquake, high pressure, acid and alkali corrosion, lightning surge, etc.

Customer information: _____

Customer name: (Mr./Ms.) _____

Product name: _____

Model: _____

Seller Information and Address: _____

Date of purchase: _____

Invoice No.: _____

